



St. Martin

C A B I N E T R Y

Affordable Luxury

St. Martin

C A B I N E T R Y

www.stmartincabinetry.com

87 Schuylkill St.
Cressona, PA
570 . 593 . 8596

100 Newfield Ave.
Edison, NJ
732 . 902 . 6020





ABOUT ST. MARTIN

The Kitchen is the heart of the home and it is our belief that luxury kitchens should offer unsurpassed quality while still being an excellent value. We manufacture frameless cabinetry in an array of styles, materials and finishes to create environments that are unique and built to match your lifestyle. Our professionally designed collections cater to your specific design and aesthetic preferences and can transform your home into a sanctuary that will bring you joy for many years to come.

Designer Collection	03
Luxury Collection	35
Classic Collection	63
Our Advantage	79
Construction	83
Finish	84
Molding	85
Choose Your Style	86

DESIGNER COLLECTION

The Designer Collection features an array of contemporary painted and stained finishes on our most popular door styles. Our painted finishes have been carefully curated to offer the best in class color and durability, while our stains on cherry and walnut hardwoods are luxurious and are painstakingly crafted in the United States.

Door Styles



Clayton Hampton Hampton Square Lakeland Lakeland-II



Bellrose Greenfield Ridgewood Newhaven Wellington

Finishes

Painted



Bright White Simply White Dove Gray Simply Gray Peppercorn



Blue Slate Oceana Blue Midnight Blue Simply Black

Stains on Cherry

Stains on Walnut



Winter Wheat Misty Gray Driftwood Cherry Natural Walnut

DESIGNER GALLERY

Blue is a fun color that evokes images of fresh water and clear sunny sky's. When added as an accent in the kitchen, imaginations wander and creativity flows. This stunning Bright White kitchen features two Oceana Blue islands that not only look great, but afford extra space for socializing and food preparation.



LAKELAND-II
Bright White



BELLROSE
Oceana Blue





LAKELAND-II

Bright White & Blue Slate



Having a lively and vibrant kitchen that flows seamlessly with the other interior spaces is essential in transitional design. The perimeter base cabinets and island in this kitchen are Blue Slate while all of the wall cabinets are Bright White. The island has cabinets placed back to back for additional storage and is capped off with a magnificent waterfall edge. A two-tone wet bar in the adjoining room is sleek and ties the two spaces together.



LAKELAND-II
Bright White



LAKELAND-II
Blue Slate



LAKELAND-II

Simply White

The monochromatic kitchen on the right is a great example of why white shaker continues to be the most popular style in the kitchen industry. White works well with almost any color selection and makes any space feel bright and airy. In this kitchen, the designer utilized brushed nickel, chrome and crystal accents to add interest to the Simply White cabinets and quartz counter-top.



LAKELAND-II
Simply White





LAKELAND

Midnight Blue

This coastal Midnight Blue wet bar throws off some serious nautical vibes. The brass hardware and back-splash make a tremendous statement and the sink and dishwasher are aesthetically pleasing, yet practical. The staggered glass cabinets provide for extra storage and the open cabinet above the sink can be used to showcase photos and display pieces.

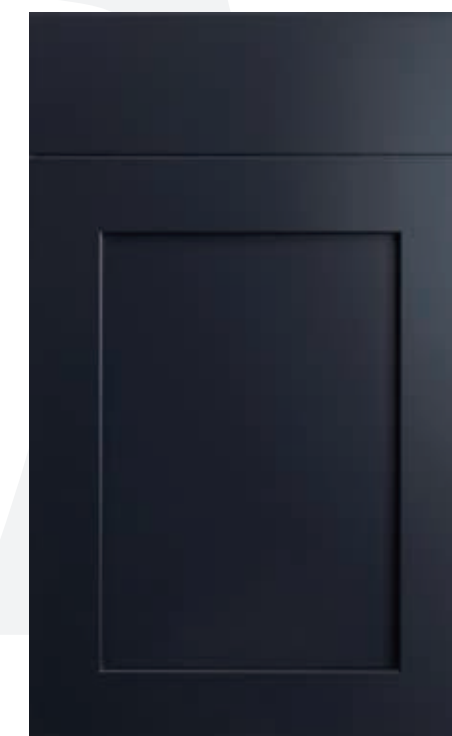

LAKELAND
Midnight Blue



LAKELAND Simply Gray



▲ This riveted stainless steel hood works perfectly with the gray cabinetry and contemporary design.

LAKELAND

Simply Gray

Gray is one of the most fashionable colors to design with at the moment because of its extreme versatility. In this kitchen, everything is gray including the Simply Gray cabinets, the stainless range hood, flooring, back-splash and lighting fixtures. Although there are numerous shades of gray used, together they artfully coalesce to create a warm and transitional environment. The designer also focused on clean lines and geometric patterns which is why almost all of the wall cabinet doors are the same width which evokes harmony and comfort.



▲ Waterfall edge, soothing grays and a built-in sink.



LAKELAND
Simply Gray





BELLROSE
Bright White &
Blue Slate



BELLROSE

Bright White & Blue Slate

This free-spirited two-tone kitchen features a Bright White perimeter and Blue Slate island. A painted St. Martin Cabinetry New Orleans hood is the centerpiece of the room and is flanked by Blue Slate wall cabinets which add interest and drama. Also incorporated are stacked cabinets for additional storage and brass hardware and lighting elements which complement the other colors masterfully.



BELLROSE
Bright White



BELLROSE
Blue Slate



BELLROSE
Dove Gray



BELLROSE
Misty Gray

BELLROSE

Dove Gray

Symmetry and simplicity are key in exceptional design. In this space, the eye is drawn towards the hood and the single Misty Gray drawer base cabinet which sits below it. Every aspect of this kitchen is symmetrical: from the counter to ceiling glass cabinets to the drawer fronts on the base cabinets.



BELLROSE

Peppercorn

This painted Peppercorn kitchen is moody, but fun. Bright white subway tile sets the stage for the dark gray color scheme to make a dramatic impact and glass cabinets with finished interiors were placed on each side of the windows to add depth.



BELLROSE
Peppercorn

GREENFIELD

Simply White



GREENFIELD
Simply White

This Simply White farmhouse kitchen blends rustic elements with contemporary sensibilities to create a laid back and stylish space. Central to the design is a two-tone New Orelans hood and a square island with a solid wood counter-top. Matching casement was used around the windows and copper was selected for the farmhouse sink to complete the rustic aesthetic.



▲ Fully integrated panels were used for the dishwasher and refrigerator to make them blend in with the cabinetry and not draw attention from the rest of kitchen.



- ◀ An art-deco masterpiece with a modern twist. Central to the space is the Simply Black island which is perfectly aligned with the white wall hood. Mullion Simply Black glass cabinets flank the hood on each side which add drama to the otherwise monochromatic perimeter.
- ▼ Two sinks in a kitchen can be convenient when entertaining guests or cooking. The designer chose to use large shaker square posts and custom island panels to complete the look.



GREENFIELD

Bright White &
Simply Black



GREENFIELD
Bright White



GREENFIELD
Simply Black

RIDGEWOOD

Bright White & Natural Walnut

This colonial style Ridgewood Bright White kitchen is timeless and elegant. The wood hood and island are finished on Natural Walnut wood species, which is known for its unique patina, color pattern and exotic wood grain. When combined with white, the brilliance and artistry of the walnut is released. This kitchen also features traditional mullion style glass doors in addition to extra large drawers below the stainless cook top.



RIDGEWOOD
Bright White



RIDGEWOOD
Natural Walnut





▲ The cooktop area was bumped out to provide extra space while cooking.

NEWHAVEN

Simply White & Midnight Blue

This two-tone New Haven kitchen is whimsical and exciting. The Simply White perimeter sets the stage for the Midnight Blue island to make a dramatic impact.



NEWHAVEN
Simply White

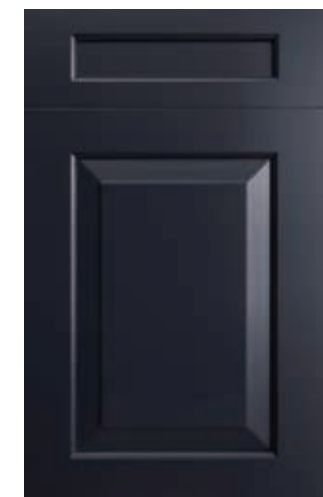

NEWHAVEN
Midnight Blue



The sink and stove areas were purposely set forward to provide extra space and were adorned with furniture toe kicks for additional drama.



▲ Open cabinetry



▲ The refined appearance of this two-tone kitchen is softened by the majestic Oceana Blue island which incorporates decorative panels for a furniture style appearance.

WELLINGTON

Bright White & Oceana Blue

The raised panel Wellington door style is sophisticated and luxurious.



WELLINGTON
Bright White



WELLINGTON
Oceana Blue

LUXURY COLLECTION

Unparalleled quality and modern finishes on our most exotic wood species. All luxury collection products are milled, fabricated and finished by hand with the finest attention to detail.

Door Styles



Clayton



Hampton



Hampton Square

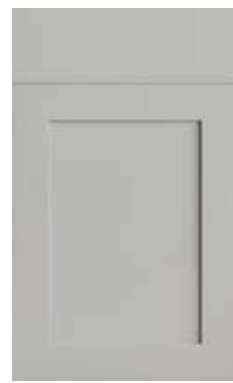

Lakeland



Lakeland-II



Bellrose

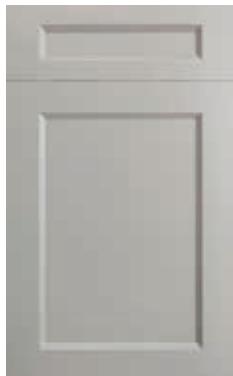

Greenfield

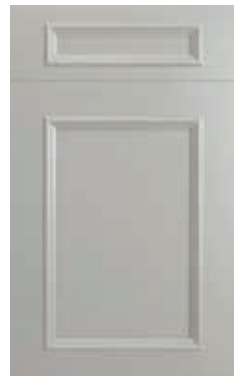

Ridgewood



Newhaven



Wellington

Finishes

Stains on Wire-brushed Rift White Oak



Rift Cut White Oak



Dusk Gray Oak

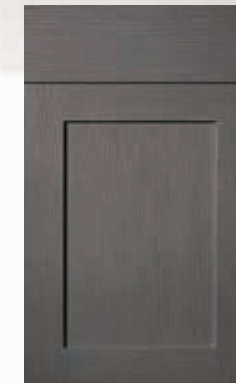

Urban Oak



Onyx Oak

Stains on Sandblasted Cherry



Weathered Cherry



Washed Desert Grey



Natural Walnut



Pewter

Stains on Walnut

Heirloom Stain & Glaze on Cherry

WIRE-BRUSHED RIFT WHITE OAK

All of our finishes on White Oak within the Luxury Collection are wire brushed to add texture and accentuate the natural grain patterns of the wood. Wire brushing is a process that involves hand-scraping the oak with a metal brush to reveal the soft grain from the growth ring of the tree. What becomes exposed after this process is the heart of the wood (hardwood) which results in a finish that has exceptional grain characteristics and appears weathered and distressed.

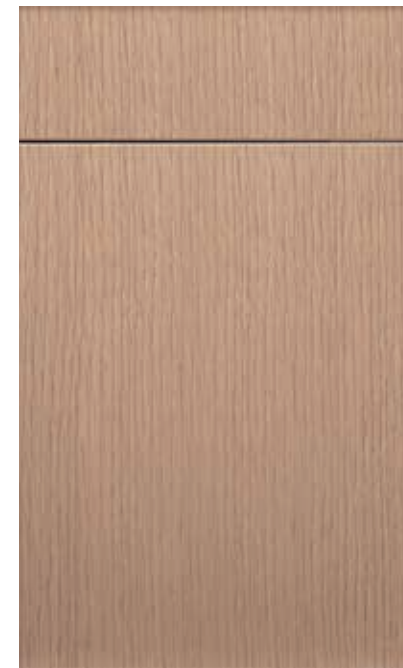

CLAYTON
Rift Cut White Oak



BELLROSE
Urban Oak



HAMPTON
Onyx Oak



LAKELAND
Dusk Gray Oak



GREENFIELD
Dusk Gray Oak



HAMPTON
Rift Cut White Oak



RIDGEWOOD
Urban Oak



RIDGEWOOD
Onyx Oak



LUXURY GALLERY

This stunning mid-century modern kitchen exudes comfort and features the Clayton door-style in Natural Rift White Oak. The white oak wood species is renowned for its straight grain and earthy coloring. All of our finishes on rift white oak are wire brushed, which gives the finish a natural texture that creates a feeling of warmth and relaxation. Also featured is a metallic black St. Martin Chateau hood with brass accents to complete the look.

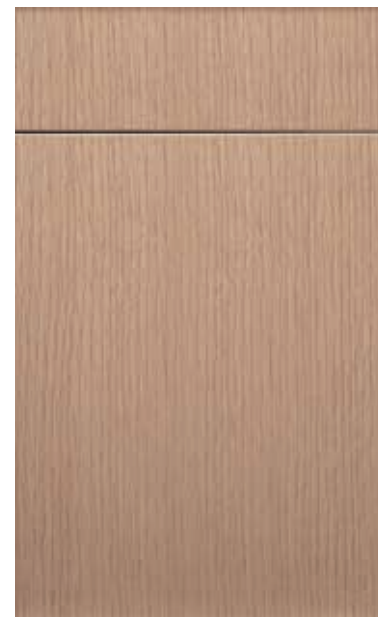

CLAYTON
Rift White Oak



HAMPTON SQUARE

Rift White Oak , Urban Oak
& Simply White



HAMPTON SQUARE

Rift White Oak

Urban Oak

Simply White

The eclectic Hampton Square kitchen shown artistically utilizes three colors to create a fun and inviting space. The natural Rift White Oak base cabinets contrast beautifully with the Peppercorn wall cabinets above, which feature LED lighting. To create cohesion, the designer completed the space by incorporating floor to ceiling Simply White cabinets on both sides and a solid carrara marble back-splash.



HAMPTON SQUARE
Rift White Oak



HAMPTON SQUARE
Urban Oak



HAMPTON SQUARE
Simply White





BELLROSE

Rift White Oak & Simply White

This two-tone Bellrose Rift White Oak and Simply White kitchen features natural materials to create a relaxed and contemporary space. The island, wall cabinet interiors and floating shelves are in Natural Rift White Oak which add warmth and vibrancy. Metal accents were used for the cabinet hardware and the trim for the wall hood, which add interest and depth. Natural stone was tastefully utilized as evidenced by the Carrara marble counter-tops and back-splash. Taken together, these elements combine to create an environment that is comfortable, but modern.



BELLROSE
Simply White



BELLROSE
Rift White Oak

SANDBLASTED CHERRY

For our Weathered and Desert Gray finishes on Cherry, we use a highly specialized process called sand-blasting to accentuate the grain and add character and texture. The process is accomplished by blasting extremely fine particulates of sand at the cherry, which darkens the wood but leaves behind natural blond highlights. Once the stain is applied, the end result is a one of a kind finish of unrivaled beauty and luxury.



GREENFIELD
Washed Desert Grey



RIDGEWOOD
Washed Desert Grey



NEWHAVEN
Washed Desert Grey



LAKELAND
Weathered Cherry



BELLROSE
Weathered Cherry



RIDGEWOOD
Weathered Cherry



NEWHAVEN
Weathered Cherry



WELLINGTON
Weathered Cherry



LAKELAND

Weathered Cherry

This sand-blasted Weathered Cherry bar is more akin to fine furniture than cabinetry. The sandblast process has created natural blonde highlights in the finish which give off a unique whitewash effect which complements the softer tones found throughout the room and the home.



LAKELAND
Weathered Cherry

HEIRLOOM STAIN & GLAZE

Our Pewter finish on cherry hardwood undergoes a rigorous stain and glaze process to create a heirloom finish. First, stain is artfully applied by hand and then a semi-transparent glaze is added for depth and dimension. The glaze is then hand-wiped to create highlights and accents to accentuate the details of the grain. The resulting wash of color creates a brilliance of unrivaled proportions.

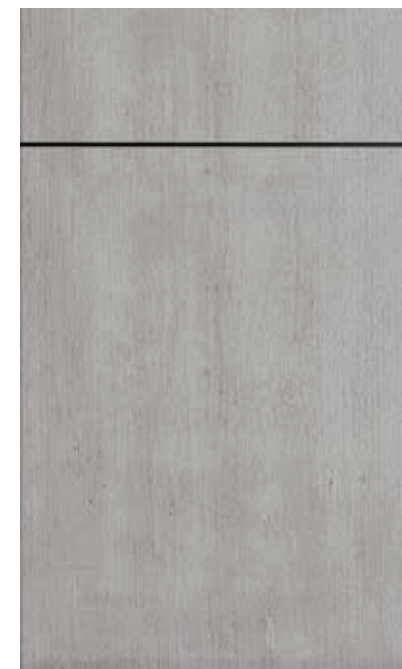

CLAYTON
Pewter



HAMPTON
Pewter



HAMPTON SQUARE
Pewter

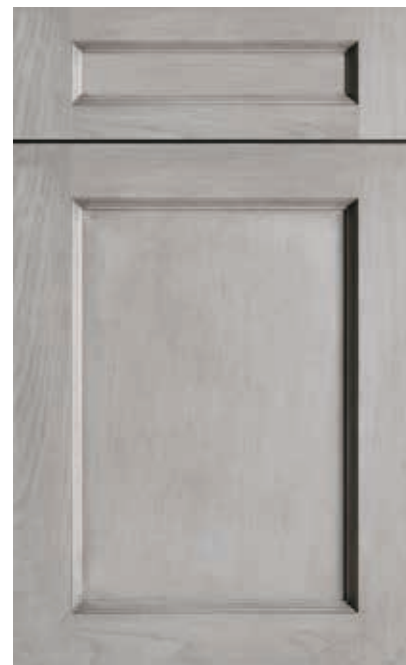

GREENFIELD
Pewter



RIDGEWOOD
Pewter

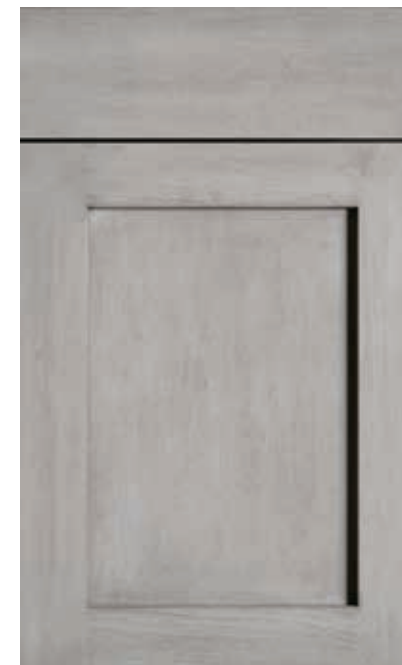

LAKELAND
Pewter



LAKELAND-II
Pewter



BELLROSE
Pewter



BELLROSE
Pewter



▲ A staggered wall open cabinet is the perfect choice for the space above the sink.



▲ Large drawers below cook-tops are the ideal place for storage of pots and pans.

BELLROSE

Pewter

This kitchen features Pewter on the contemporary Belrose door style. Modern appliances, chrome accents, LED lighting and the custom island complete the space.



BELLROSE
Pewter



RIDGEWOOD

Pewter

The weathered and aged look of our Pewter finish paired with copper and natural accents evokes an idyllic space one might find in the French countryside.



RIDGEWOOD
Pewter

STAIN FINISH

Natural Walnut

This Mid-century modern marvel showcases our contemporary Clayton door style in natural walnut wood veneer. The walnut is grain matched to give runs of cabinetry uniformity and warmth. Splayed leg furniture, dark stainless appliances and the custom island complete this masterpiece.

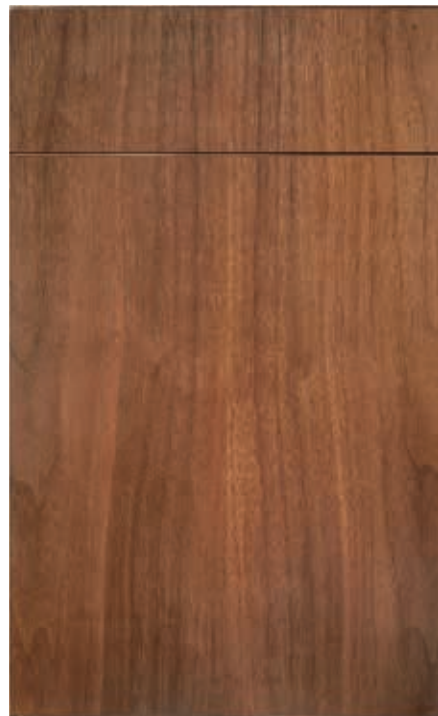

CLAYTON
Natural Walnut



HAMPTON
Natural Walnut



HAMPTON SQUARE
Natural Walnut

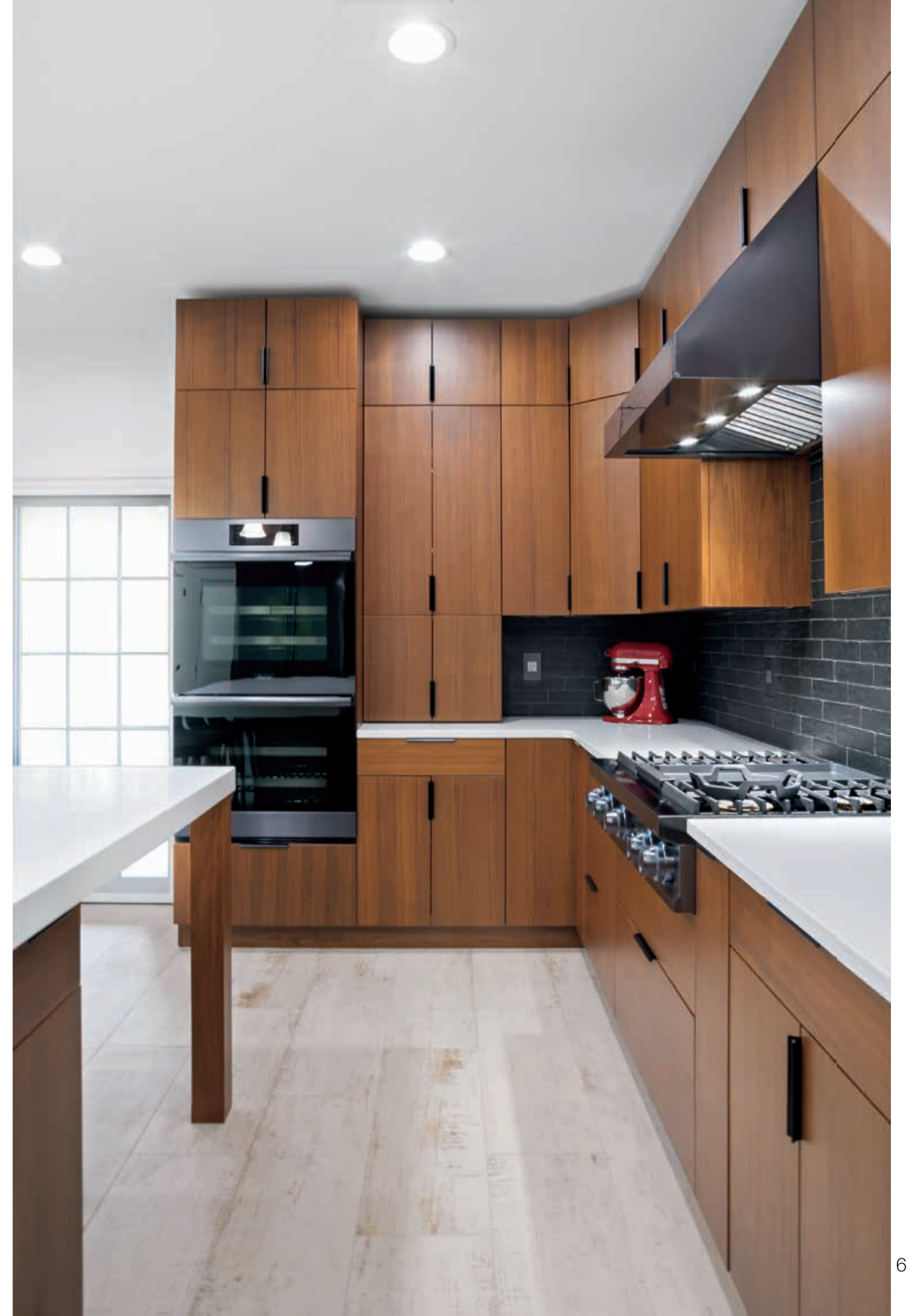



CLAYTON
Natural Walnut

CLASSIC COLLECTION

While trends may change, some things never go out of style which is why this collection includes tried and true stains and glazes on cherry and alder hardwoods.

Door Styles

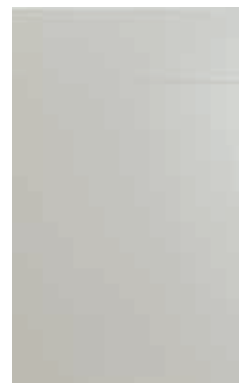

Clayton



Hampton



Hampton Square



Lakeland

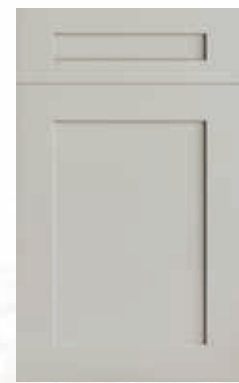

Lakeland-II



Bellrose

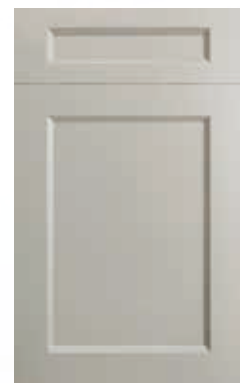

Greenfield



Ridgewood

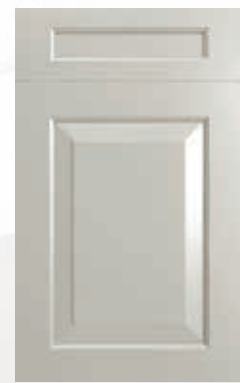

Newhaven



Wellington

Finishes

Stains on Cherry

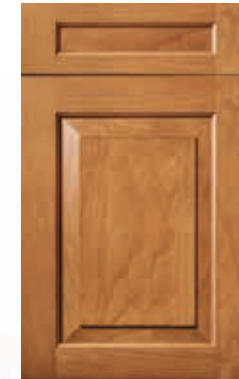

Ginger Cherry



Cherry Golden Honey



Cherry Cognac



Cherry Chestnut



Cherry Black Walnut

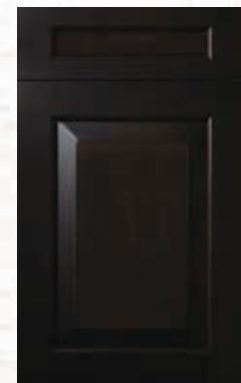

Gunsmoke

Heirloom
Paint & Glaze



Gray Stone

Stains on Alder



Alder Cognac

Restored &
Distressed



Anitque Black



CLASSIC GALLERY

Sometimes less is more and this minimalist space proves it. The dark cherry Gunsmoke cabinets blend in seamlessly with the dark wood floors which results in a neat, fluid and relaxing environment.



LAKELAND
Gunsmoke





▲ The hallmarks of Scandinavian design are the use muted colors, modern furniture and fixtures, natural lighting and wood accents.



▲ The cabinet to the left of the exterior door was custom built with a false decorative panel on the front and an open side on the end for storage.

BELLROSE

Simply White & Cherry Chestnut



BELLROSE
Simply White

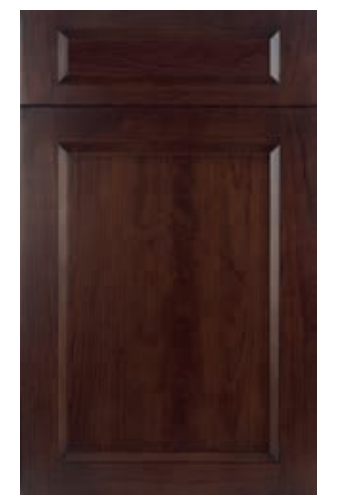

BELLROSE
Cherry Chestnut



GREENFIELD

Bright White /

WELLINGTON

Gray Stone

This classic, All-American kitchen features timeless accents that have been popular since our nation's inception. Mullion glass doors match the exterior doors and windows throughout the home and the dark oak floor provides a lovely contrast to the Bright White and Gray Stone cabinetry. Modern flourishes were also included such as the built-in microwave drawer in the island and the stainless hood above the cook-top.



GREENFIELD
Bright White



WELLINGTON
Gray Stone

RIDGEWOOD

Simply White & Cherry Golden Honey

This lakeside Simply White and Cherry Cognac kitchen is bright, open and airy. The space features a St. Martin Chateau wall hood, which is a statement piece that matches the glass wall cabinet interiors and island.



RIDGEWOOD
Simply White



RIDGEWOOD
Cherry Golden Honey





RIDGEWOOD

Bright White &
Cherry Cognac



RIDGEWOOD
Bright White



RIDGEWOOD
Cherry Cognac

◀ Warm wood-tones, oak floors, and stainless accents make this cottage style kitchen the perfect place to spend a lazy summer day.

GREENFIELD

Simply White /
WELLINGTON
Antique Black

The combination of Simply White and Antique Black in this kitchen is bold, yet sophisticated. The gorgeous furniture style island centers the room and provides ample room for seating, socializing and food preparation.



GREENFIELD
Simply White /
WELLINGTON
Antique Black



GREENFIELD
Simply White



WELLINGTON
Antique Black



OUR ADVANTAGE



1 | Locally Sourced Lumber

We select the finest American grown hardwoods, including Rift White Oak, Walnut, Cherry, Alder & Paint-Grade, from our local forests to ensure our cabinets are made from the highest quality materials possible.

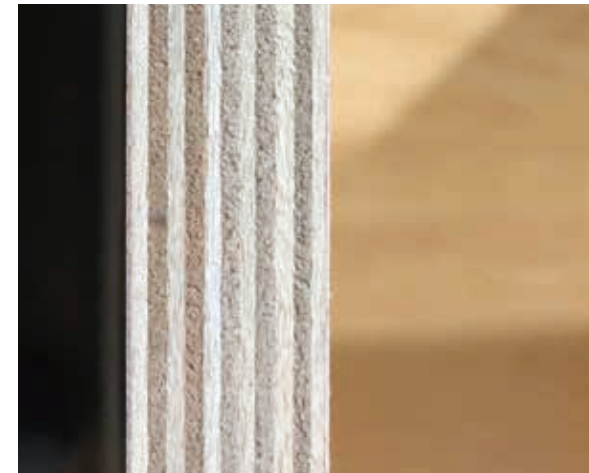

4 | Superior Construction

Every cabinet we produce is certified Carb 2 compliant and built to the highest specification possible to ensure durability and longevity. Our standard all-wood box construction features premium 9-ply plywood for structural integrity, squareness and precision. As an added bonus, almost every part of our cabinet is edge-banded and laminated, including the tops, sides and bottoms to reduce warping and the harmful effects of water.

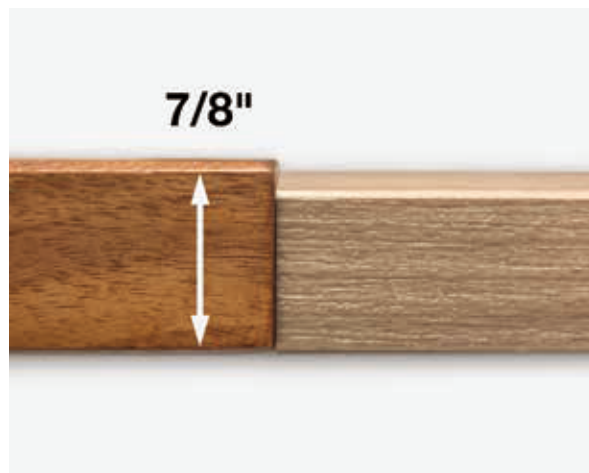

2 | Exceptional Door Standard

Our standard door thickness is 7/8" as opposed to the industry standard of 3/4". By making our doors thicker, the overall kitchen is given additional depth and elegance and the overall feel is one of quality and stability.



5 | Supreme Storage

Our full access, frameless construction maximizes storage and accessibility in the kitchen. Because our cabinetry does not have a frame that protrudes into the cabinet opening, the interior is readily accessible which makes storing large platters, cookware and plates easy. While most wall cabinets are manufactured 12" deep, our wall cabinets are 13" deep as a standard to provide even more storage for larger household items.



3 | Uncompromising Furniture Finish

Once we select premium quality lumber, we meticulously match and hand-sand each-piece. The material then undergoes a 14-step finishing process that ends with the application of a catalyzed conversion topcoat to prevent scratching and scuffing. During every stage of the manufacturing process, our products undergo a thorough evaluation to guarantee that the end product is immaculate.



6 | European Style Ever-Lock Shelf

Our shelves are crafted from solid 3/4" plywood which is edge-banded on all four sides and then finished with a sophisticated European style front edge. In addition to being aesthetically unique, each shelf we manufacture is designed with stability in mind and features our ever-lock system. This system utilizes stainless steel shelf clips that lock into pre-drilled holes that are bored into the bottom of the shelf to prevent movement and ensure the sturdiness of the shelf and overall structure of the cabinet.

OUR ADVANTAGE



7 | Soft-Close Full-Extension Drawer Box

Our solid maple, 3/4" drawer box features dovetail joinery and a 3/8" bottom for added support and load resistance. Every drawer box we manufacture features soft-close, full-extension under-mount hardware to maximize storage space and make operation a breeze.



8 | Leveling Feet

Leaks, spills and minor floods are common in the kitchen which is why every St. Martin cabinet sits on leveling feet to prevent it from wicking up minor amounts of water. This will ultimately increase the longevity of your kitchen and also prevent musty smells that occur when wood soaks up moisture.



9 | Stress Free Warranty

We put quality first and believe products should be built to last which is why we offer a limited-lifetime warranty on all of our products.



10 | Frameless Inset Design

Our professionally designed products can be given an inset look by utilizing fillers in between cabinets, decorative panels at the end of runs and crown and light rail moldings at the top and bottom of wall cabinets. This frameless inset style is elegant and timeless and will not require the constant adjustments found on traditional inset cabinetry.

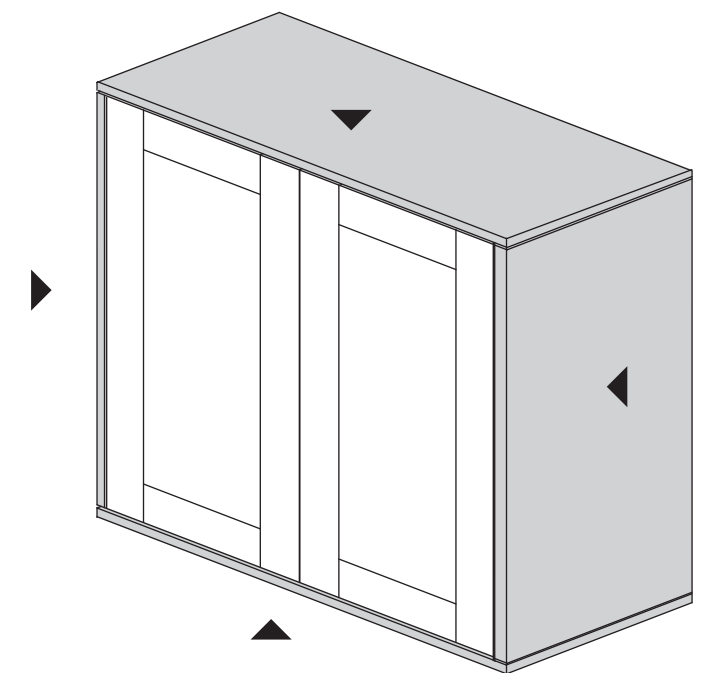

CONSTRUCTION



A	Shelves	3/4" plywood with a durable wood-grain washable melamine. Solid wood edge banding.
B	Sides	3/4" plywood with a durable wood-grain washable melamine interior.
C	Doors	7/8" solid woods and hand selected wood veneers in several outstanding finishes.
D	Drawer Front	7/8" solid woods and hand selected wood veneers in several outstanding finishes.
E	Drawer Box	3/4" solid maple featuring dovetailed joinery at the corners. The drawer bottom is 3/8" plywood with a natural maple melamine face.
F	Floor and Ceiling	3/4" plywood with a durable wood-grain washable melamine interior.
G	Toe Kick	A 3/4" unfinished plywood toe kick comes standard on every cabinet and then a 3/4" finished plywood toe kick is applied. Toe space is 4 1/2" high.
H	Shelf Supports	Metal shelf clips slide into pre-drilled holes in the shelf for added strength and stability.
I	Hinges	Blum six-way adjustable soft closing hinges on most cabinets.
J	Back	Plywood with a durable wood-grain washable melamine interior.
K	Slides	Concealed, undermount, full-extension slides with a 70 lb. capacity.

14-STEP FURNITURE FINISH

We take several additional steps - 14 in all - to provide the finest finish available. All finishes are skillfully applied to ensure a smooth and durable surface.

1. Hand Sanding	Each wood component is checked for uniformity and then hand-sanded with 400 grit sand paper.
2. Base Color	Base color is applied by hand spray and allowed to air dry for thirty minutes.
3. Wash Coat	Wash coat is applied by hand spray.
4. Air Drying & Oven Cure	Each component air dries for five to ten minutes and then is oven cured for thirty minutes.
5. Hand Sanding	All surfaces are lightly hand-sanded with 320 grit sand paper.
6. Hand-wiped Stain Application	Stain is hand-wiped to enhance wood grain details.
7. Air Drying	Each component air dries for an additional five to ten minutes.
8. Toner Coat	A final finish adjustment is applied to ensure consistent color on all pieces.
9. Air Drying & Oven Cure	Toned parts are placed into drying ovens to cure for thirty minutes.
10. Sealer Coat	Parts receive a sealer coat to increase durability.
11. Hand Sanding	Sealed surfaces are hand sanded with 400 grit sand paper creating a smooth and uniform surface.
12. Top Coat	A premium quality catalyzed conversion varnish top coat is applied making our products scratch, scuff, moisture and stain resistant.
13. Air Drying & Oven Cure:	Each component air dries five to ten minutes and then is oven cured for thirty minutes.
14. Quality Inspection	Our last step is a rigorous final inspection ensuring that each finished part meets our very rigid quality standards.



CROWN & LIGHT RAIL MOLDING

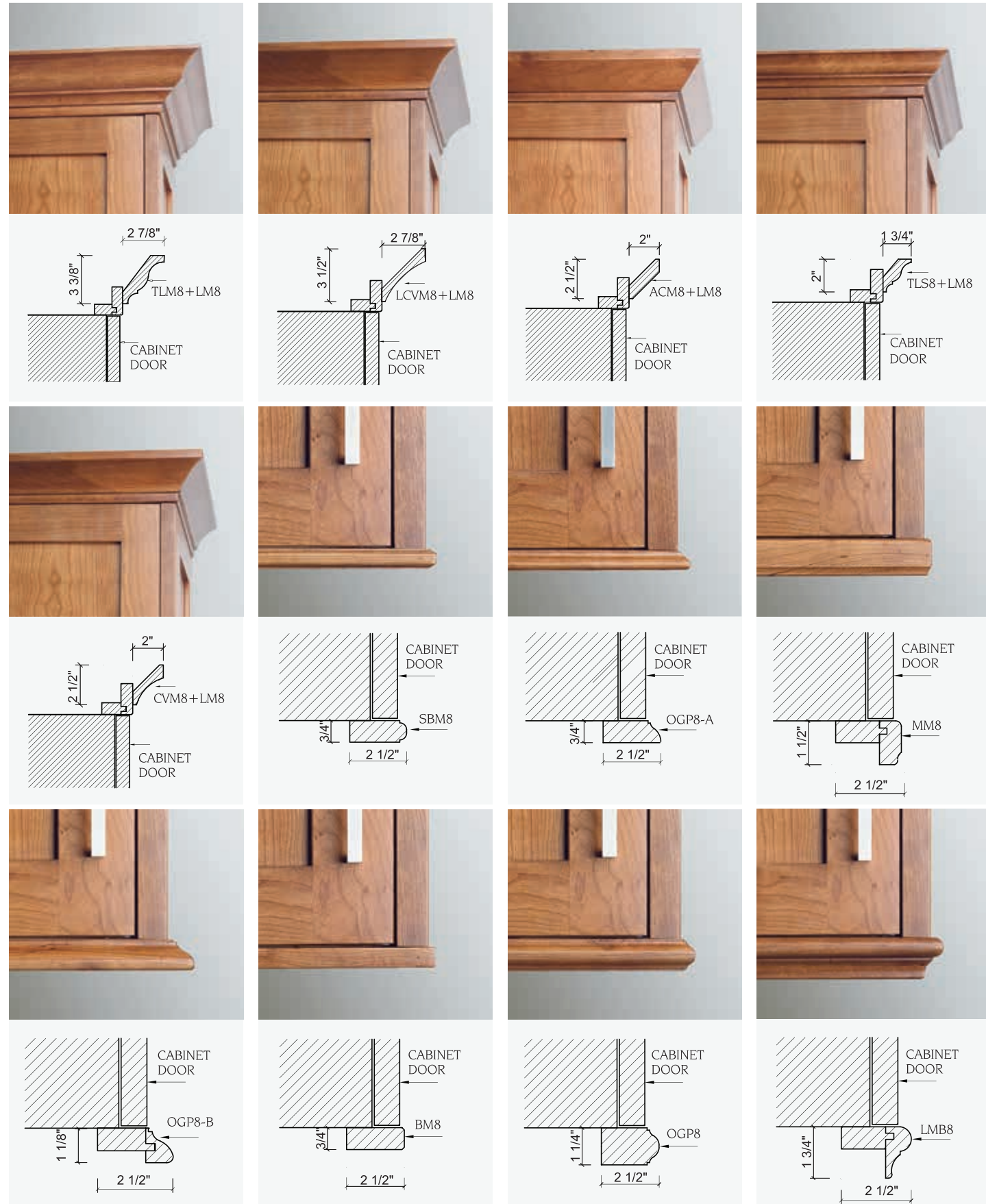

CHOOSE YOUR STYLE

CREATE THE LOOK YOU LOVE

Did you know that we have 233 exquisite door and finish combinations? To aid you during the design process, our website has the Choose Your Style selection tool. This tool allows you to visualize each door and finish combination so you can select the look that you love!

WWW.STMARTINCABINETRY.COM

SHARE YOUR STYLE

Want to see more amazing kitchens submitted by happy customers or share photos of your space with us? Go to the Share Your Style section of our website to learn more.

WWW.STMARTINCABINETRY.COM

